

Name _____

Date _____

THE UNITED STATES GOVERNMENT

The president and Congress are a part of the federal government. We elect the president and the president lives and works in the White House. Congress makes laws for the country. We elect people in each state to work in Congress. Congress meets in the U.S Capitol.

Draw a line from each description to the correct building.

Descriptions

- This is where Congress meets.
- The president lives here.
- Laws are made in this building.
- Leaders from around the world often visit the president here.
- The president does most of his work here.
- People elected from all states work here.

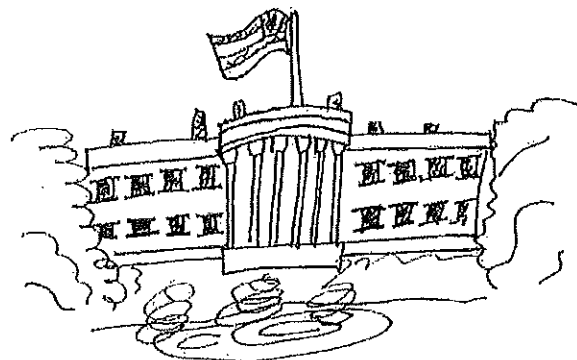

White House

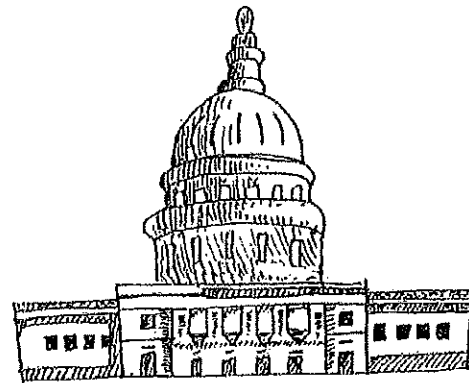

U.S. Capitol

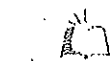

Government Building Match-up

Match-up each building's name and fill in the blanks.

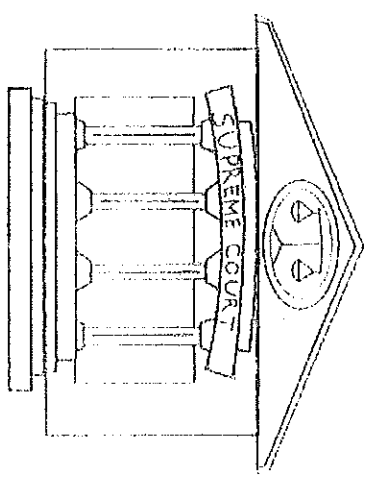
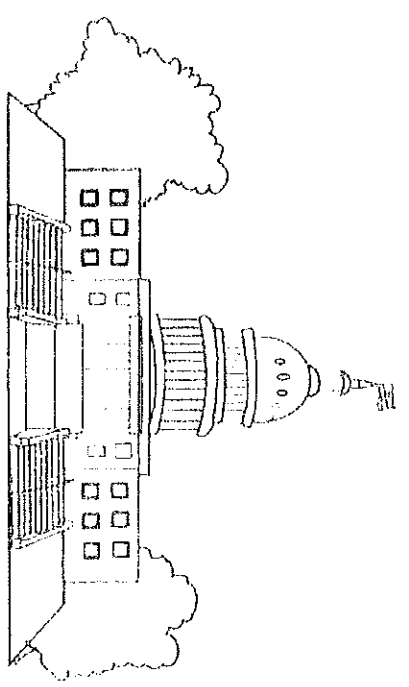
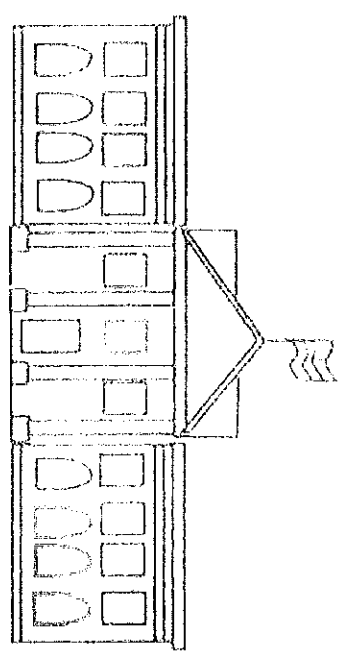

Name: _____

Who works here: _____

- | | | |
|---------------|------------------------|---------------------|
| SUPREME COURT | CAPITOL BUILDING | MEMBERS OF CONGRESS |
| THE PRESIDENT | SUPREME COURT JUSTICES | |
| WHITE HOUSE | | |

Name : _____

The Three Branches of the U.S. Government

Complete the table with words from the word box.

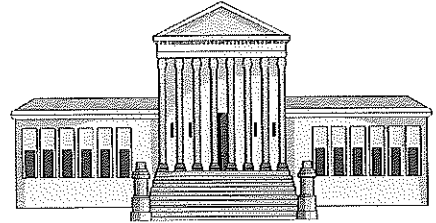
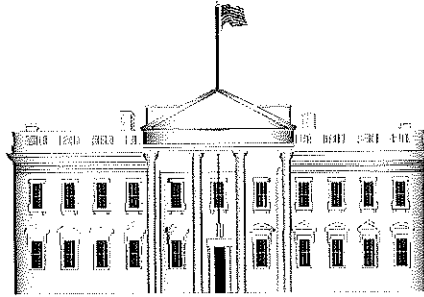
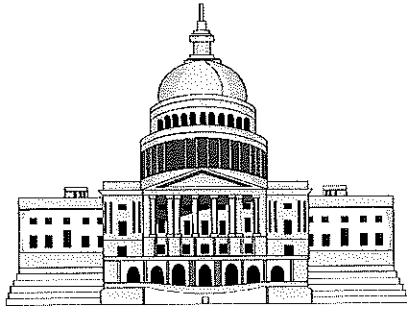

LEGISLATIVE	EXECUTIVE	JUDICIAL

President		Vice President
	Congress	
Supreme Court		Cabinet
	Senate	
House of Representatives		Other Federal Courts

3 Branches of Our Government



FILL IN THE BLANKS IN THE SENTENCES BELOW

1. What are the 3 branches of our government? _____
2. The _____ Branch of our government makes the laws.
3. The _____ Branch of our government enforces our laws.
4. What are the two parts of our Congress? _____ and _____
5. There are _____ senators.
6. The _____ is elected by eligible United States citizens who vote and by the Electoral College system.
7. _____ and _____ are elected by voters in their states.
8. _____ study laws to see if they are correct according to the Constitution.
9. Where do the major branches of our federal government meet and work?

10. The _____ is the leader of the Executive Branch of our government.

The Three Branches of Government

Executive Branch

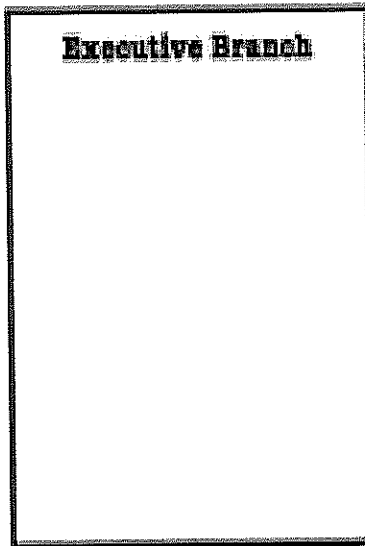

Legislative Branch

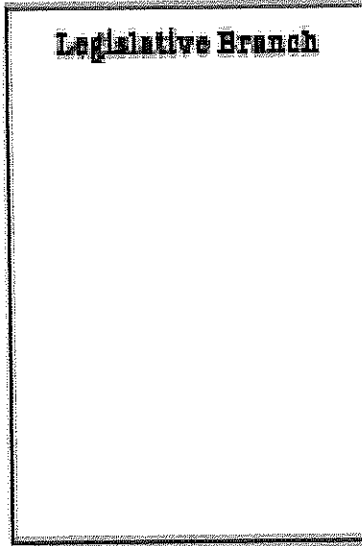

Judicial Branch

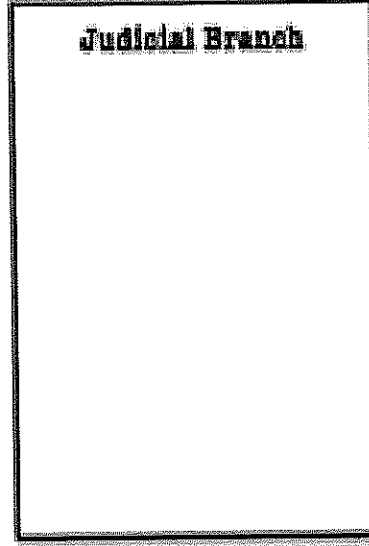

The President

Makes Laws

The White House

Congress

**Makes Sure Laws
are Fair**

**U.S. Capitol
Building**

**Supreme Court
& Judges**

Enforces Laws

**Supreme Court
Building**